



IG829

Healthcare Area Imager Barcode Scanner

SCANTECH ID[®]
CHAMPTEK Group

Introduction

IG829 is a handheld area imager medical barcode scanner which is purpose-built for healthcare environments, a disinfectant-ready housing delivering maximum protection against the spread of bacteria, with special antimicrobial additives necessary to withstand cleaning processes.

IG829 has most modern design with rugged casing and supports IP42 sealing protection, with its unmatched performance for the majority of 1D, 2D and medical UDI bar codes increasing your productivity. Healthcare workers can switch between vibrate and beeper feedback by simply depressing the trigger for a few seconds. An optional stand can be ordered to facilitate hand-free reading application.

At auto-sense mode, it senses an object approaching and turns on the light to read barcodes. With its Intelligent Activation, it automatically switches over from button trigger mode to auto-sense mode while placing scanner on its stand.

IG829 provides customer with the most cost-effective solution and is perfectly suitable and definitely the best choice for any healthcare application environment.

Features

- A disinfectant-ready housing (ISO 22196 and JIS Z2801) protects your investment with durable construction that is better able to resist the harmful effects of harsh chemicals.
- Designed as IP42 sealing protection.
- Support 1D, 2D, UDI and GS1 Databar codes.
- Good performance on both display and printed label reading.
- Support automatic sense reading and is able to read under 0 Lux dark environment.
- With intelligent activation, it automatically switches over to automatic-sense reading while placed on the stand.
- Controllable user-selectable feedback designed for a quiet night shift (vibration) or a busy and more noisy day shift (beeper).
- Support multiple interface options, USB HID, Virtual COM and RS-232.
- Both contact and air 16KV Electro-Static discharge.
- A stand option can be ordered to facilitate hand-free reading options.



IG829

Barcode	Depth of field
3mil Code39	30~ 70 mm
4mil Code39	20~ 80 mm
5mil Code39	20~100 mm
6mil Code39	20~120 mm
10mil Code39	20~170 mm
13mil Code39	20~200 mm
20mil Code39	20~250 mm
20mil QR Code	20~180 mm
20mil PDF417	20~110 mm
20mil Data Matrix	20~180 mm

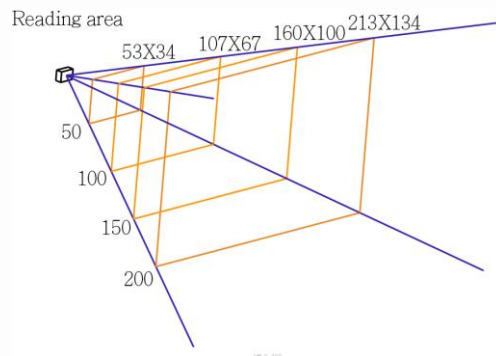

Note:
The test is under ambient light 700 ~800 Lux.

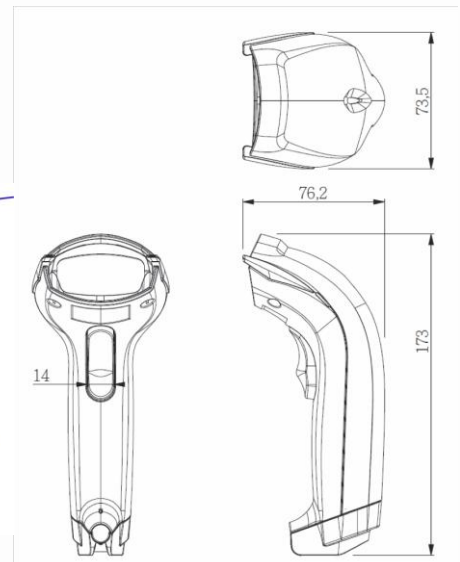

Mechanical Drawing
Unit: mm

Specifications

Physical Characteristics

Weight	
Body weight	Approx. 110g / 3,88 oz
Material	
	ABS / Rubber
Cable Length	
	5 FT. (150cm)
Dimension	
	73.5 mm W x 76.2 mm H x 173.0 mm L
Color Available	
	White

Electrical Characteristics

Interface	RS232	USB
Supply Voltage		
Output Voltage (Typ.)	±9V	+5V
Output low Voltage (Max.)	-	0.7V
Current Draw		
Stand by (Typ.)	45 mA	40mA
Operation (Typ.)	440 mA	370 mA

Performance

Light Source	White light LED
Sensor	1280 (H) x 800 (V) pixels
Field of view	Horizontal – 55°;Vertical – 35°
Scan Rate	60 fps (at full resolution)
Reading Distance	250mm@20mil/0.5mm, PCS90%
Print Contrast Ratio	PCS25%@5mil/0.127mm
Resolution	3mil/0.076mm@PCS90% Code39, 8mil/0.2mm@PCS90% QRCode
Reading Angle	
Pitch Angle	Test Conditions : Code 39, 10mil/0.25mm,PCS90%
Skew Tolerance	5°~60° (±5°)
Ambient Light	
	100,000 Lux Max.
Sealing	
	IP42 Water and dust protection

Environmental

Operating Temperature	0 °C to 50 °C (32 °F to 122 °F)
Storage Temperature	-20 °C to 70 °C (-4 °F to 158 °F)
Relative Humidity	20% to 95% (Non-condensing)
Antibacterial resistance	ISO 22196 and JIS Z2801

Reliability

Life Time	
Trigger Switch	1,000,000 times @1kg ±50g cycles
MTBF(Calculated)	50,000 hours
Thermal Shock	
High Temp.	60 °C (140 °F)
Low Temp.	-20 °C (-4 °F)
Cycle time	30 minutes for high temp. , 30 minutes for low temp.
Cycles	24 cycles
Cable Bending Test	25,000 times minimum (30 times/min @ 200g/90°)
Drop Resistance	70.86 inches (180cm) drop on concrete surface
Electro-Static Discharge	Both contact and air at up to 16KV

Readable Symbolologies

1D Symbolologies

UPC-A, UPC-E, EAN-8/JAN-8, EAN-13/JAN-13, Code 39, Code 128, Interleaved 25, Industrial 25, Matrix 25, Codabar/NW7, Code 93, China Post, MSI/Plessey, Telepen, GS1 Databar Omni-directional, GS1 Databar Limited, GS1 Databar Expanded

2D Symbolologies

QR Code, PDF 417, Micro QR Code, Micro PDF417, Data Matrix, Aztec, Dotcode

Due to Champtek/Scantech ID's continuing product improvement programs, specifications and features are subject to change.