

SPECIFICATION

Customer: _____

Customer's Model No.: _____

Model No.: **LYRA L-9080i**

**Hybrid Desktop Presentation and Handheld
Area Imager Barcode Scanner**

Date: _____

Sample Serial No.: _____

Spec. Version & Revision Date: V02 2021.04.27

Received/Approved by

SCANTECH ID[®]
CHAMPTEK Group

Web: <http://scantech-id.com>
E-mail: sales@scantech-id.com

SCANTECH ID
Heliumweg 34a 3812 RE Amersfoort,
The Netherlands

TEL: +31 (0) 33 4698400
FAX: +31 (0) 33 4650615

Revision History

Version	Date	Context
V00	2019.07.17	Release
V01	2021.04.15	Add RS232 Cable
V02	2021.04.27	Modify Depth of field

TABLE OF CONTENTS

A.	General Description	4
B.	Physical Characteristics	5
C.	Connecting	6
D.	Powering	6
E.	Electrical Characteristics	7
F.	Performance	7
G.	Environmental	8
H.	Reading Range	8
I.	Usage mode and Indicator table	9
J.	Readable Symbologies	10
K.	Reliability	10

A. General Description

The LYRA family is a multi-form, compact size, omni-directional presentation area-imaging scanner engineered to decode all standard 1D and 2D barcodes. Its revolutionary imaging technology is housed in an elegant, stylish, yet durable design. The compact size and small foot-print design, makes it the ideal solution for space-constrained environments.

With the **LYRA L-9080i**, you get the versatility to scan any 1D or 2D bar code — from the printed labels in retail that identify product or mobile bar codes on the screen of a mobile phone, and pricing at the register to mobile coupons, mobile gift and loyalty cards, boarding passes and even theater tickets. The LYRA provides all the features you need to keep your workers productive; intuitive and fast reading performance; true point-and-shoot scanning simplicity — no need to align bar code and scanner; and hands-free and handheld flexibility.

The LYRA reader includes powerful configuration tool, programming bar code and data formatting functionality which allow easy integration into existing or new host systems, management to manage maintenance.



B. Physical Characteristics

Weight

Body weight	Approx.315g
RS232 Cable weight	Approx. 85g
USB Cable weight	Approx. 55g
Material	ABS Plastic
Connector	RJ 48C 10 Pin
Dimension (WxDxH)	97.89 x 74.90 x 137.94 mm
Color Available	Black

Note : scanner head can be forward (Max 90°) and backward (Max 90°) tilting adjusted in a total 180° range to accommodate to your application need.

Body Dimension

Unit: mm 97.89(W) x 74.90(D) x 137.94(H)



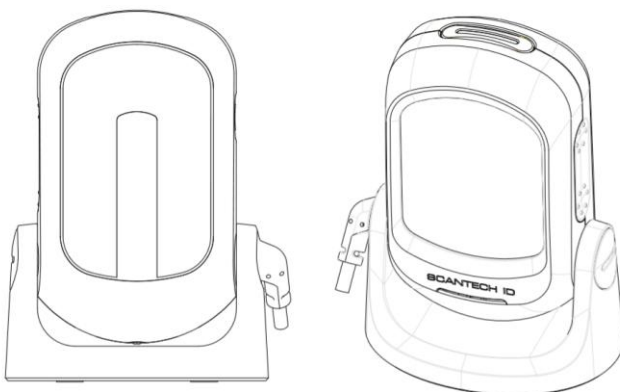
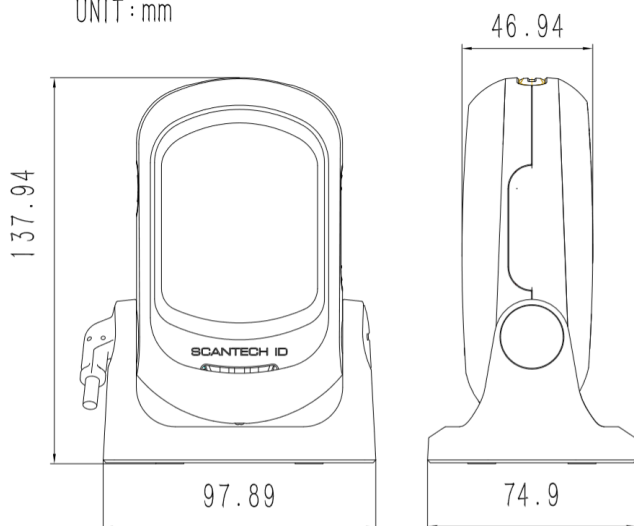

UNIT : mm

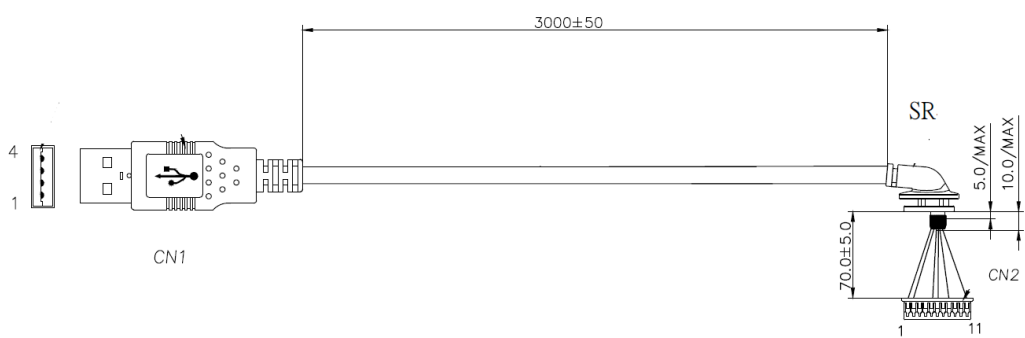

C. Connecting

Interface Selection

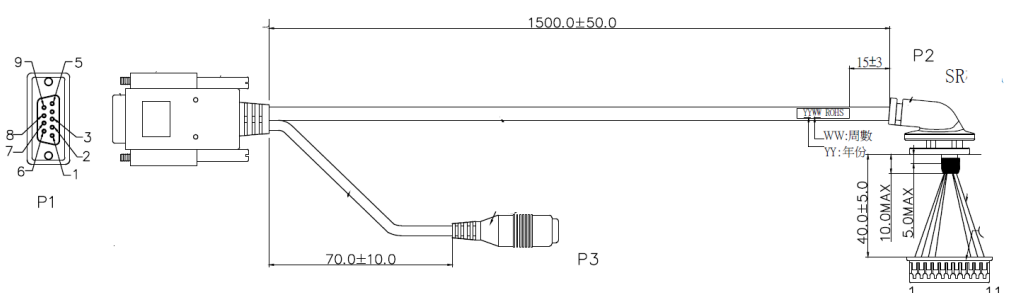
LYRA allows you to connect your host system using two different interface cables, RS232 or USB.

Interface Cable	Connector type
<p data-bbox="135 698 794 734">USB Black (Product Number: 0114-LY00001)</p> 	<p data-bbox="1204 683 1353 750">USB connector</p> 
<p data-bbox="135 1191 821 1227">RS232 Black (Product Number: 3114-LY00041)</p> 	<p data-bbox="1204 1176 1353 1243">DB9 connector</p> 

D. Powering

LYRA power is designed by USB+5V, do not need power supply once the interface is USB, but will request power supply for RS232 interface.

E. Electrical Characteristics

Interface	RS232	USB
Supply Voltage	DC Adaptor +5V \pm 5%	USB Power
Stand-by (Typ.)	95 mA	90 mA
Operation (Typ.)	320 mA	310 mA

F. Performance

Light source	Visible White LED
View of field	Horizontal – 55°, Vertical – 35°
Depth of field	210mm@20mil/0.5mm, PCS90%
Resolution	1280 (H) x 800 (V) pixels 3.0 mil (Code 39), 8 mil (QR Code)
Scan speed	60 scans per second
Pitch	\pm 60°(from front to back)
Skew	\pm 60°(from plane parallel to symbol(side- to-side))
Roll	360°
Interface	RS-232 or USB
Indicators	Beep and LED

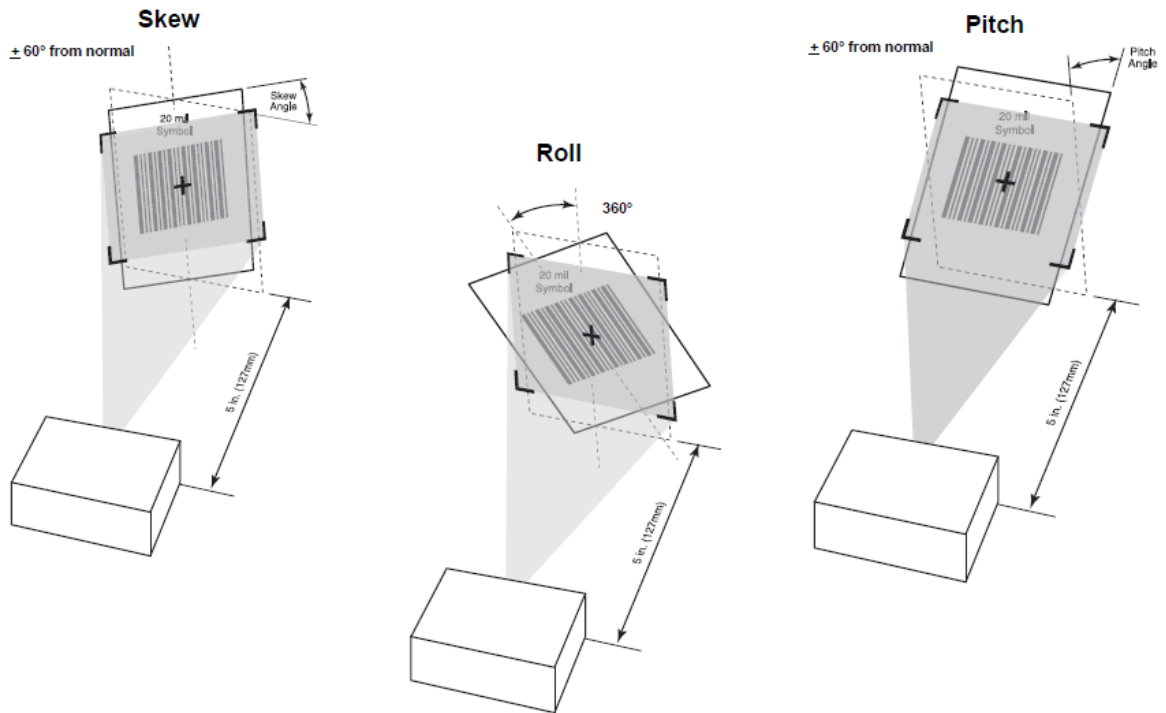

G. Environmental

Operating Temp.	0°C to 50°C (32°F to 122°F)
Storage Temp.	-20°C to 70°C (-4°F to 158°F)
Relative Humidity	5% to 95% (Non-condensing)
Sealing	Designed to IP42 water and dust protection

H. Reading Range

Barcode	Depth of field
3mil Code39	0 ~ 60 mm
4mil Code39	0 ~ 90 mm
5mil Code39	0 ~ 120 mm
10mil Code39	0 ~ 150 mm
20mil Code39	0 ~ 210 mm
20mil QR Code	0 ~ 150 mm
20mil PDF417	0 ~ 150 mm
20mil Data Matrix	0 ~ 150 mm

Note : The test is under ambient light 700~800 Lux.

Near distance is Field of View (FOV) limited by barcode's size.

I. Usage mode and Indicator table

Usage	Action	LED	Beeper
Desktop usage (Auto-Sense mode)	In stand-by	Orange light	
	Successful reading	Blue Blink 1 time	Be
Handheld usage (Trigger mode)	In stand-by	Blue light	
	Successful reading	Orange Blink 1 time	Be

Note : The LYRA is default booting at desktop “Auto-sense reading mode”, if you press the touch button on side of LYRA, it will be switched to the “Trigger reading mode”, you can then hold it to simulate as a handheld scanner. The LYRA will automatically switch back to the desktop “Auto-sense reading mode” while there is no scan in 3 seconds.



J. Readable Symbologies

1D Symbologies	Readable	Default Enable
UPC-A	V	V
UPC-E	V	V
EAN-8/JAN-8	V	V
EAN-13/JAN-13	V	V
Code 39	V	V
Code 128	V	V
Codabar/NW7	V	V
Interleaved 25	V	V
Industrial 25	V	
Matrix 25	V	
Code 93	V	
China Post	V	
Code 11	V	
MSI/Plessey	V	
Telepen	V	
GS1 Databar Omni-directional	V	
GS1 Databar Limited	V	
GS1 Databar Expanded	V	

2D Symbologies	Readable	Default Enable
Aztec	V	
Data Matrix	V	V
PDF 417	V	V
Micro PDF 417	V	
QR Code	V	V
Micro QR Code	V	
DotCode	V	

K. Reliability

Life Time	
MTBF(Calculated)	50,000 hours
Temp. Test	
High Temp.	70°C, 48 hours
Low Temp.	-20°C, 48 hours
Cable Bending Test	25,000 times minimum (30 times/min @ 500g/90°)
Drop Resistance	47.24 inches(120cm) drop on concrete surface
Electro-Static Discharge	Both contact and air at up to 20KV